



knikerboker
the art of hand made



2025 NEWS
HOME LIGHTING SCULPTURES



INDEX

Pag. 5	Sconquasso
9	Zona D'ombra
15	Zona D'ombra Small
19	Le Piccoline
23	Nuvole di Drago
27	Punto!
31	Doppiozero sospensione
35	Chiave di Sol



SCONQUASSO

Sconquasso is the lamp that shakes up the ordinary: a shot in the centre of a **metal disc** creates an adjustable light that irradiates the space with personality and strenght. An **impactful design**, created to leave its mark.



Sconquasso 60 p/pl

Wall/ceiling lamp
hand-thumped steel Ø cm 60

Steel base Ø cm 12,5X4

Spread cm 20/22

Weight kg 6

1 led COB
14W - max 350mA
2900 Lm emitted
3000°K - CRI>85
Phase cut dimmable
power supply included

2700°K and other dimming
ways on request

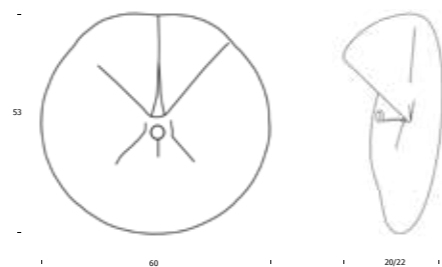

Sconquasso 100 p/pl

Wall/ceiling lamp
hand-thumped steel Ø cm 100

Steel base Ø cm 14X4

Spread cm 31/33

Weight kg 8

1 led COB
14W - max 350mA
2900 Lm emitted
3000°K - CRI>85
Phase cut dimmable
power supply included

2700°K and other dimming
ways on request

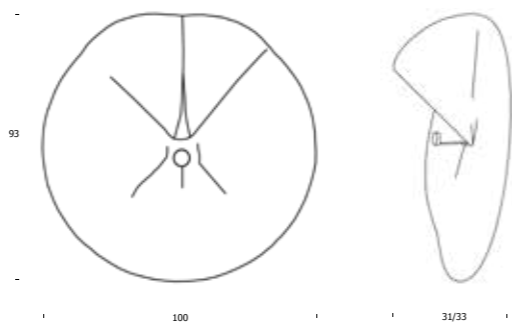

Sconquasso 150 p/pl

Wall/ceiling lamp
hand-thumped steel Ø cm 150

Steel base Ø cm 16,5X5,5 adjustable

Spread cm 45/48

Weight kg 16

1 led COB
14W - max 350mA
2900 Lm emitted
3000°K - CRI>85
Phase cut dimmable
power supply included

2700°K and other dimming
ways on request

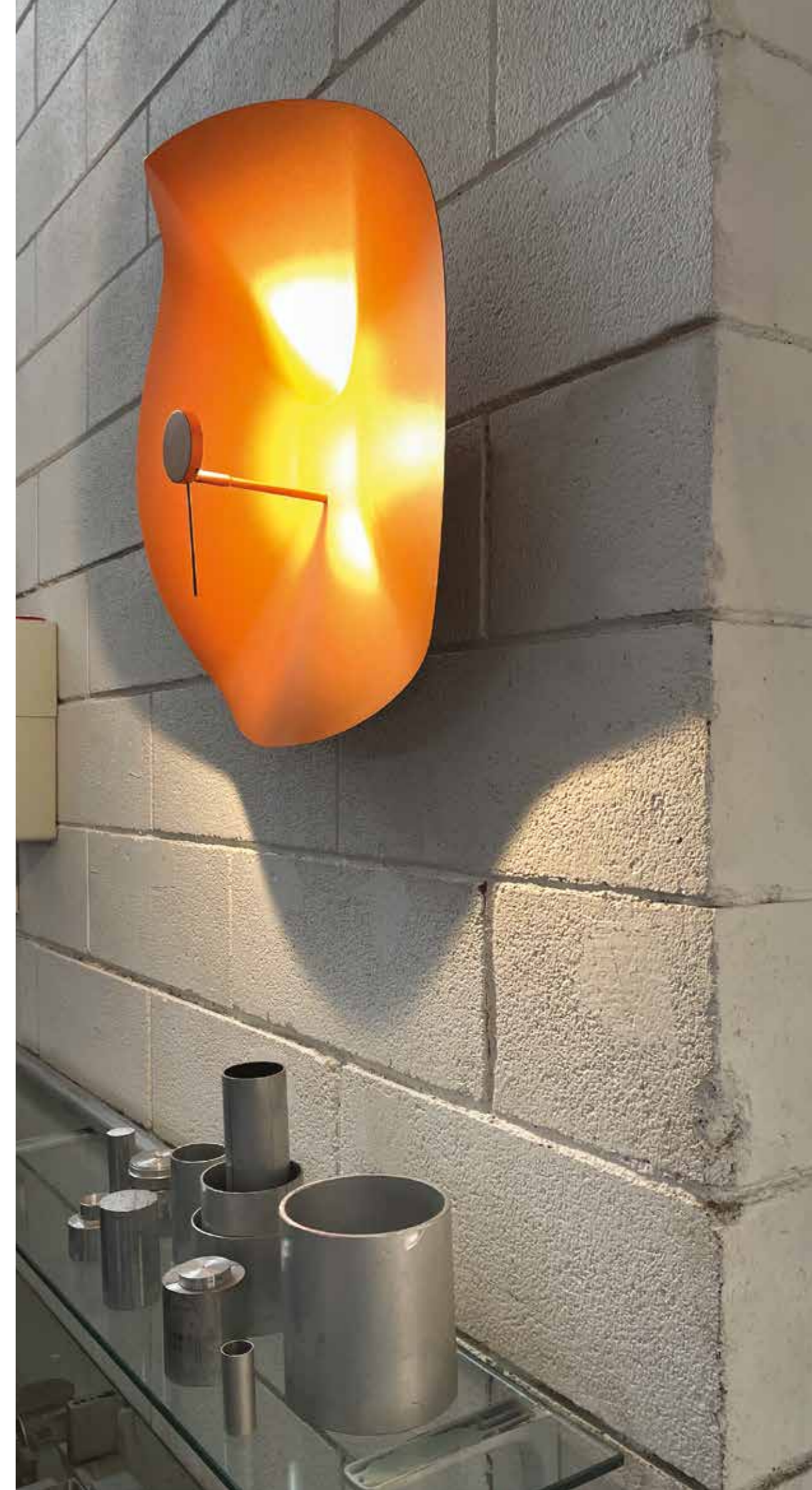
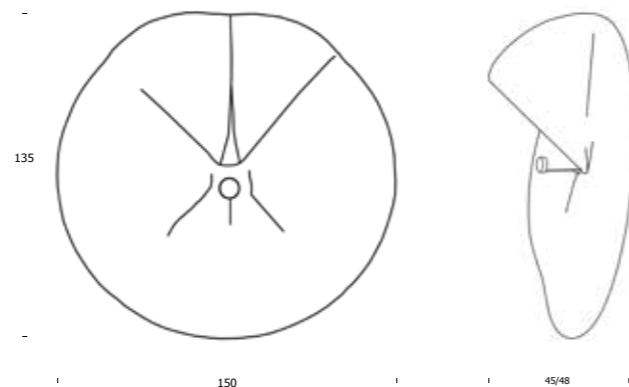



ZONA D'OMBRA

an irregular, hand-beaten sheet illuminated by the beam produced by one or two **spotlights** creates alternating of flashes and **shadows** that chase each other capturing our gaze.

zona d'ombra A p/pl a 1

Wall/ceiling lamp
hand-thumped steel
cm 108X92

Steel base Ø cm 14X4,5

Spread +/- cm 25 - 30

Weight kg 4,8

1 led COB
14W - 350mA
2900 Lm emitted
3000°K - CRI 85
Phase cut dimmable
power supply included

2700°K and other dimming
ways on request

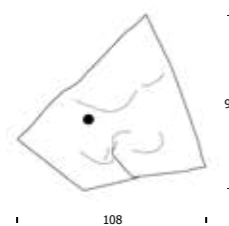

zona d'ombra A p/pl a 2

Wall/ceiling lamp
hand-thumped steel
cm 108X92

Steel base Ø cm 14X4,5

Spread +/- cm 25 - 30

Weight kg 5,2

2 led COB
14W - 350mA
3900 Lm emitted
3000°K - CRI 85
Phase cut dimmable
power supply included

2700°K and other dimming
ways on request

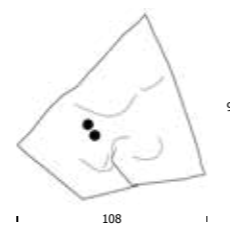

zona d'ombra B p/pl a 1

Wall/ceiling lamp
hand-thumped steel
cm 120X90

Steel base Ø cm 14X4,5

Spread +/- cm 25 - 30

Weight kg 5

1 led COB
14W - 350mA
2900 Lm emitted
3000°K - CRI 85
Phase cut dimmable
power supply included

2700°K and other dimming
ways on request

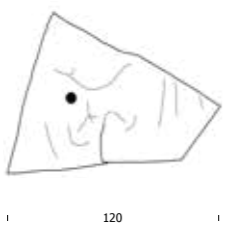

zona d'ombra B p/pl a 2

Wall/ceiling lamp
hand-thumped steel
cm 120X90

Steel base Ø cm 14X4,5

Spread +/- cm 25 - 30

Weight kg 5,4

2 led COB
14W - 350mA
3900 Lm emitted
3000°K - CRI 85
Phase cut dimmable
power supply included

2700°K and other dimming
ways on request

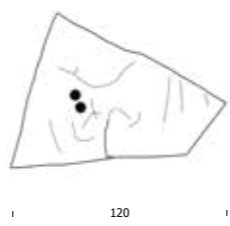



zona d'ombra A sosp a 1

Suspension lamp
hand-thumped steel
cm 108X92

Steel base Ø cm 16X6

3 steel cables cm 200
Silicon cable cm 200

Spread +/- cm 26/28

Weight kg 5,4

1 led COB
14W - max 350mA
2900 Lm emitted
3000°K - CRI>85
Phase cut dimmable
power supply included

2700°K and other dimming
ways on request

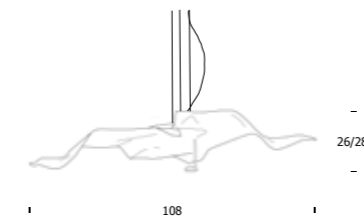

zona d'ombra B sosp a 1

Suspension lamp
hand-thumped steel
cm 120X90

Steel base Ø cm 16X6

3 steel cables cm 200
Silicon cable cm 200

Spread +/- cm 24/26

Weight kg 5,8

1 led COB
14W - max 350mA
2900 Lm emitted
3000°K - CRI>85
Phase cut dimmable
power supply included

2700°K and other dimming
ways on request

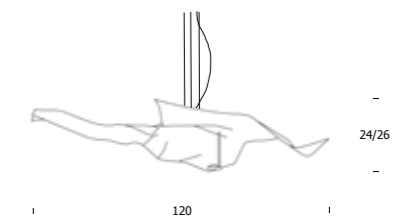

zona d'ombra A sosp a 2

Suspension lamp
hand-thumped steel
cm 108X92

Steel base Ø cm 16X6

3 steel cables cm 200
Silicon cable cm 200

Spread +/- cm 26/28

Weight kg 5,4

2 led COB
14W - max 350mA
3900 Lm emitted
3000°K - CRI>85
Phase cut dimmable
power supply included

2700°K and other dimming
ways on request

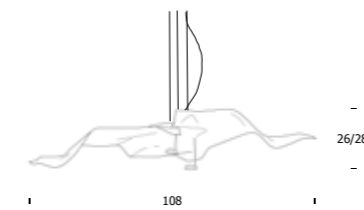

zona d'ombra B sosp a 2

Suspension lamp
hand-thumped steel
cm 120X90

Steel base Ø cm 16X6

3 steel cables cm 200
Silicon cable cm 200

Spread +/- cm 24/26

Weight kg 5,8

2 led COB
14W - max 350mA
3900 Lm emitted
3000°K - CRI>85
Phase cut dimmable
power supply included

2700°K and other dimming
ways on request

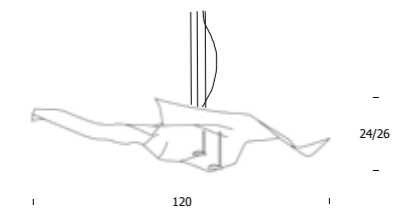

ZONA D'OMBRA small



zona d'ombra small p/pl

Wall/ceiling lamp
hand-thumped steel
cm 79X41

Steel base Ø cm 11,5X3,5

Spread +/- cm 23 - 26

Weight kg 2,3

1 led COB
14W - 350mA
2900 Lm emitted
3000°K - CRI 85
Phase cut dimmable
power supply included

2700°K and other dimming
ways on request

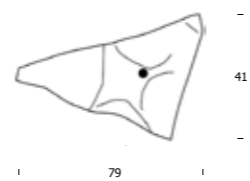

zona d'ombra small sospensione

Suspension lamp
hand-thumped steel
cm 79X41

Steel base Ø cm 12,5X4

3 steel cables cm 200
Silicon cable cm 200

Spread +/- cm 23 - 26

Weight kg 4,1

1 led COB
14W - 350mA
2900 Lm emitted
3000°K - CRI 85
Phase cut dimmable
power supply included

2700°K and other dimming
ways on request

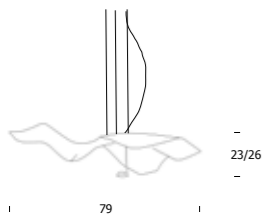



PICCOLINE^{LE}

a **mignon-sized** light jewel with great character.
This lamp, modular in cascades of small and elegant
elements, refracts light in shimmering plays
decorating the space with refinement.

le piccoline a 32

Suspension lamp
hand-thumped steel
32 piccoline
cm 12X11X11

Steel base cm 125X22X7

Silicon coaxial cables
n. 8 cm 100
n. 8 cm 150
n. 8 cm 200
n. 8 cm 250

Lamps weight kg 5
Base weight kg 11

32 ministar module
134,4W - 350mA
13120 Lm emitted
3000°K - CRI > 90
Dimmable
power supply included

2700°K on request

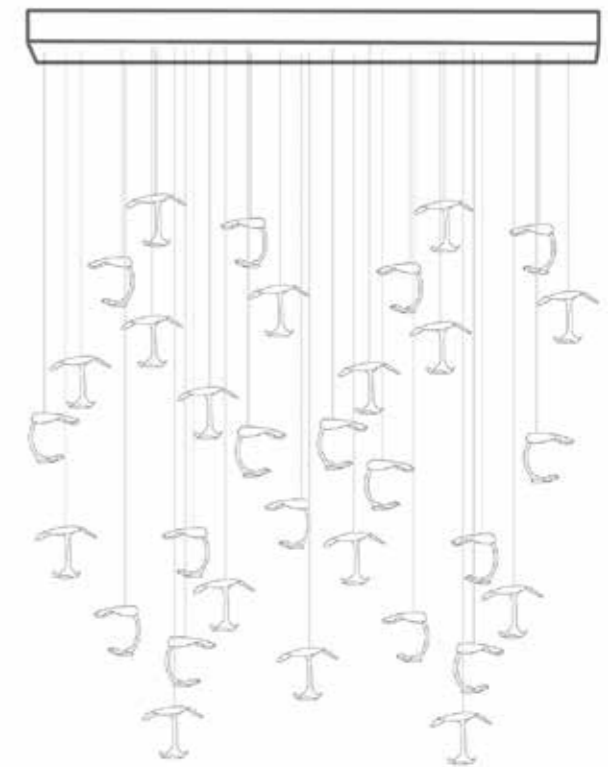



le piccoline a 5

Suspension lamp
hand-thumped steel
5 piccoline
cm 12X11X11

Steel base Ø cm 24,5X5

Silicon coaxial cables
n. 2 cm 100
n. 2 cm 150
n. 1 cm 200

Lamps weight kg 0,6
Base weight kg 3

5 ministar module
21W - 350mA
2050 Lm emitted
3000°K - CRI > 90
Dimmable
power supply included

2700°K on request



le piccoline a 1

Suspension lamp
hand-thumped steel
cm 12X11X11

Steel base Ø cm 7,5X3,5

Silicon coaxial cables cm 150

Weight kg 0,3

Ministar module
4,2W - 350mA
410 Lm emitted
3000°K - CRI > 90
Dimmable
power supply included

2700°K on request



NUVOLE DI DRAGO

like when you look at the sky at night and see clouds shining, this time, however, they are **gold** and **copper**. delicate and airy; a multitude of fine threads of different materials woven into this precise warp.

and just as when it rains at night, the drops can only be seen against the light, as well as the imperceptible thread that supports these light shiny **clouds**.



nuvole di drago

Suspension lamp
15 small clouds
in brass and copper
interlaced wire meshes
cm 100X150

Aluminium base
cm 18X9X3,5

Weight kg 1,3

Led bar
25W max 700mA
4000 Lm emitted
3000°K - CRI 85
Phase cut dimmable
power supply included

2700°K and other dimming
ways on request

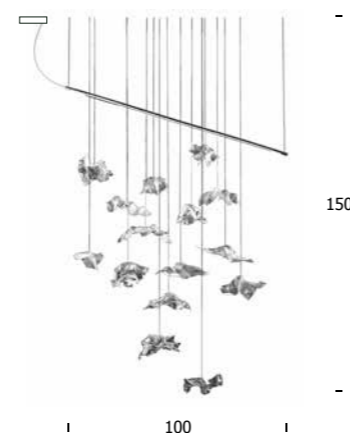



nuvole di drago special

nuvola 1

Suspension lamp
1 small cloud
in brass or copper
interlaced wire meshes
cm 17X8

Steel base
Ø cm 12,5X4

Silicon coaxial cable cm 150

Weight kg 0,30

1 led
3W - max 700mA
300 Lm emitted
3000°K - CRI>80
Power supply included

2700°K on request



| 17 |





PUNTO!

SNODO

minimalist and elegant without that touch of luxury that only plated gold gives you. **Punto**, or translated "period" is perfect for giving shine, even when the light is off.

enrich the environment with this small but impactful jewel; bedrooms, hallways, entrances, **the list goes on...**

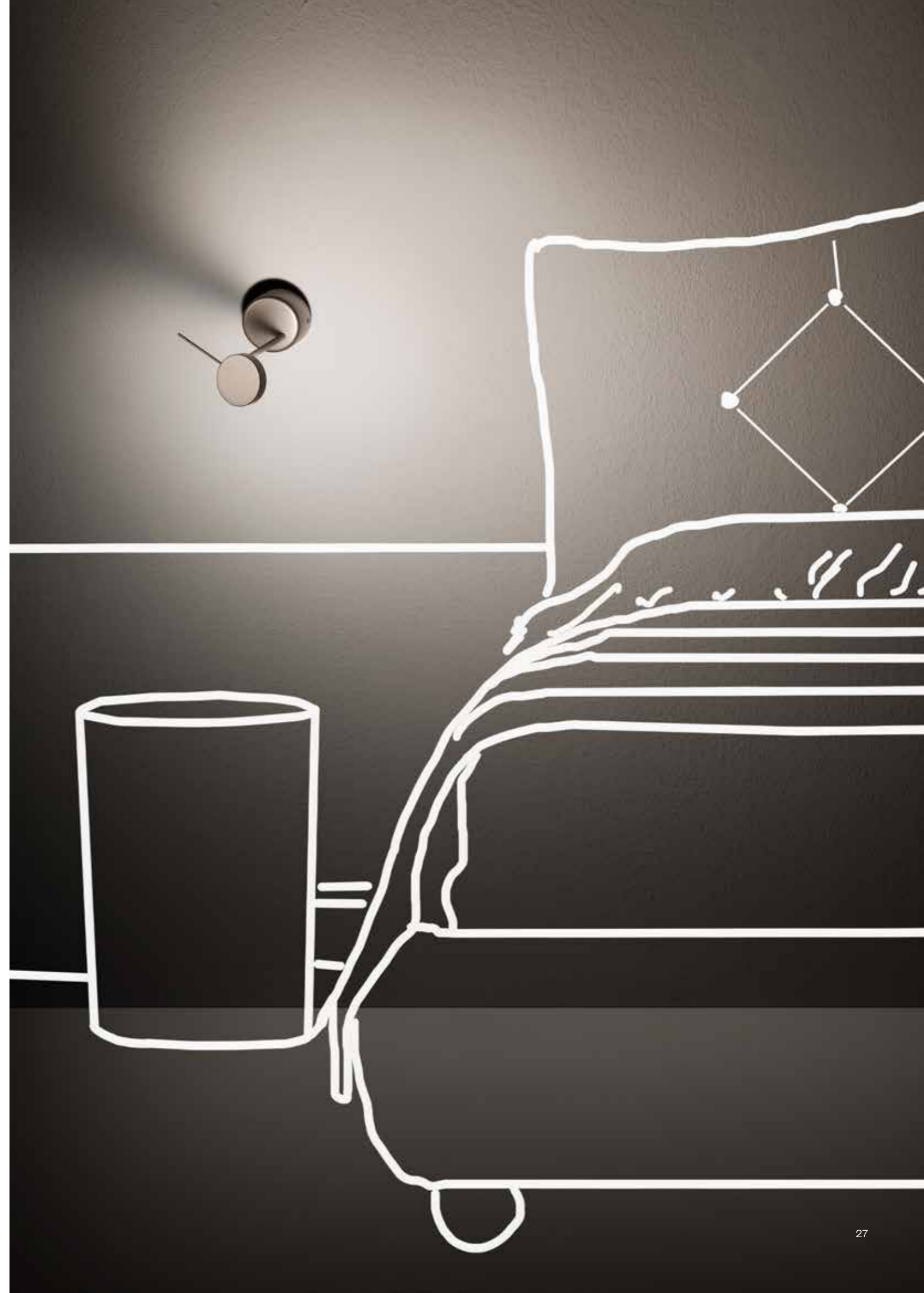
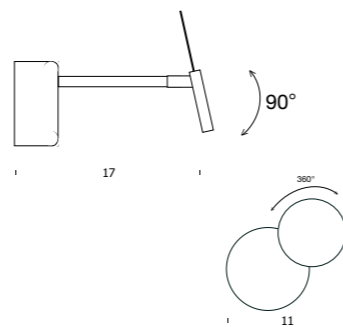

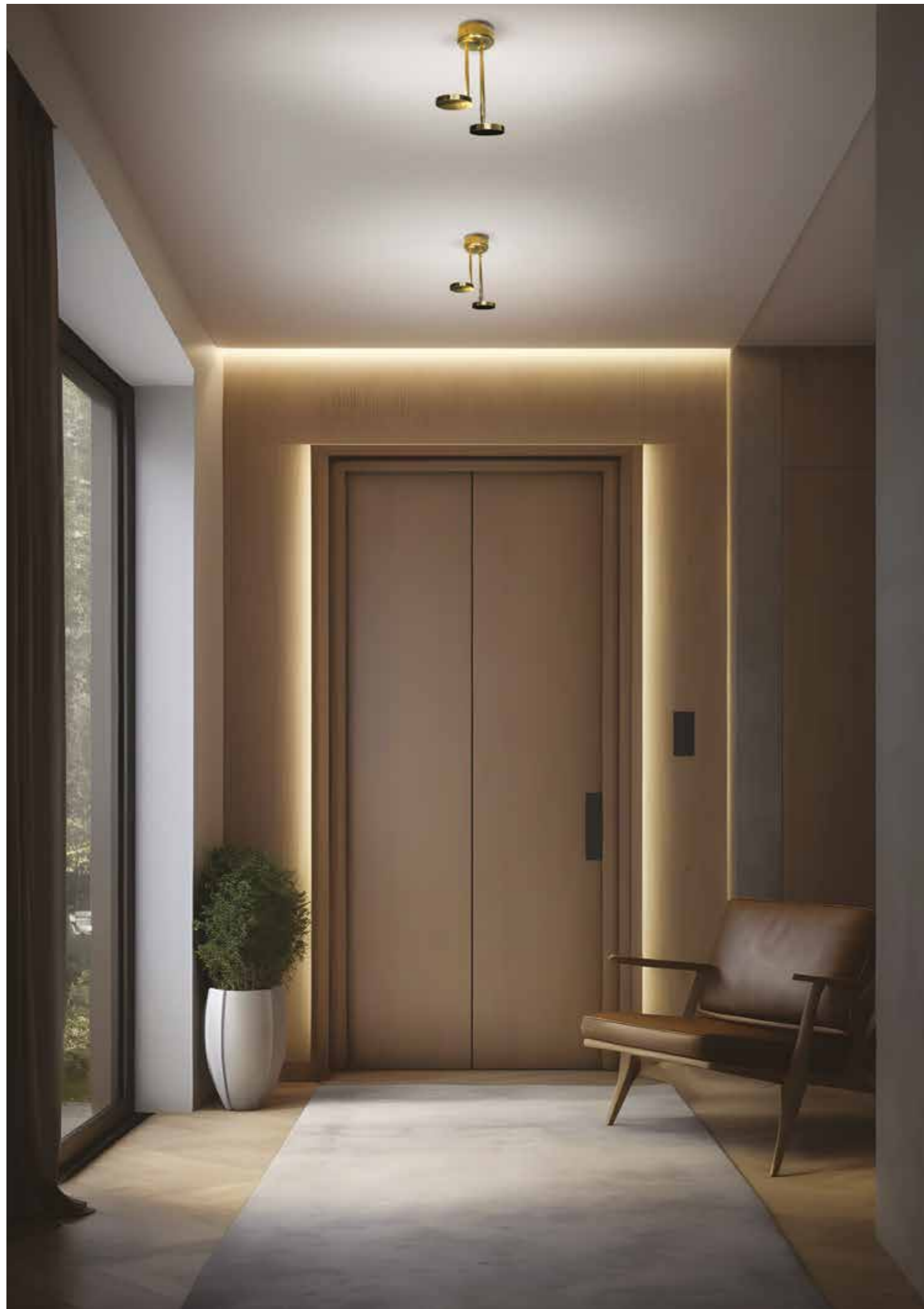

PUNTO!

PARETE/PLAFONE

punto! 1 p

Wall lamp
in polished steel
ø cm 11X17

Steel base ø cm 7,5X4

Spread cm 17

Weight kg 0,3

1 led COB
14W - 350mA
2900 Lm emitted
3000°K - CRI 85
Phase cut dimmable
power supply included

2700°K on request

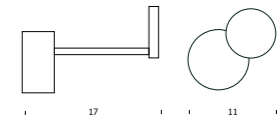

punto! 1 pl

Ceiling lamp
in polished steel
ø cm 11X21

Steel base ø cm 7,5X4

Spread cm 21

Weight kg 0,3

1 led COB
14W - 350mA
2900 Lm emitted
3000°K - CRI 85
Phase cut dimmable
power supply included

2700°K on request

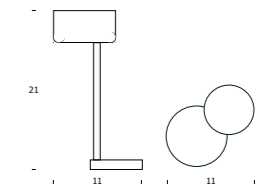

punto! 2 p

Wall lamp
in polished steel
ø cm 14X21

Steel base ø cm 7,5X4

Spread cm 20

Weight kg 0,4

2 led COB
14W - 350mA
3900 Lm emitted
3000°K - CRI 85
Phase cut dimmable
power supply included

2700°K on request

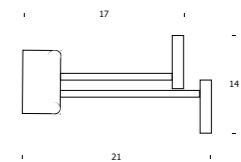

punto! 2 pl

Ceiling lamp
in polished steel
ø cm 14X25

Steel base ø cm 7,5X4

Spread cm 25

Weight kg 0,4

2 led COB
14W - 350mA
3900 Lm emitted
3000°K - CRI 85
Phase cut dimmable
power supply included

2700°K on request

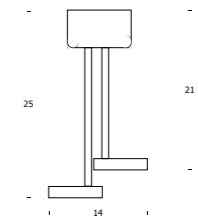

DOPPIOZERO

SOSPENSIONE

hanging from a thread, no holes or welding, just a game of precision and **balance**.





doppiozero 25 s

Suspension lamp
in polished steel
Ø cm 25X12

Steel base
Ø cm 12,5X3

Silicon coaxial cable cm 150

Weight kg 1,1

1 led COB
14W - 350mA
2900 Lm emitted
3000°K - CRI 85
Phase cut dimmable
power supply included

2700°K and other dimming
ways on request

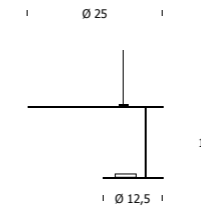

doppiozero 30 s

Suspension lamp
in polished steel
Ø cm 30X14

Steel base
Ø cm 12,5X3

Silicon coaxial cable cm 150

Weight kg 1,3

1 led COB
14W - 350mA
2900 Lm emitted
3000°K - CRI 85
Phase cut dimmable
power supply included

2700°K and other dimming
ways on request

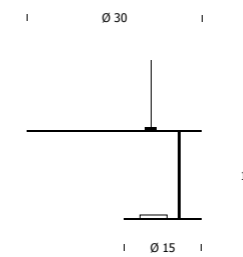

doppiozero 40 s

Suspension lamp
in polished steel
Ø cm 40X17

Steel base
Ø cm 12,5X3

1 steel cable cm 200
Silicon coaxial cable cm 200

Weight kg 2,6

1 led COB
14W - 350mA
2900 Lm emitted
3000°K - CRI 85
Phase cut dimmable
power supply included

2700°K and other dimming
ways on request

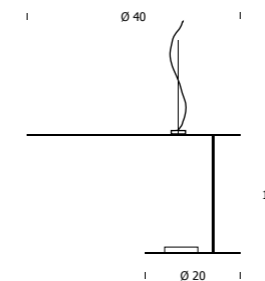

CHIAVE DI SOL

not your regular home sculpture

it is no mystery as to why historically gold is considered the most precious of allows.

maintaining the charm of the baroque and adding the elegance and simplicity of the line, this **musical note** gives off luster, dazzling the observer with a warm and mysterious light.



chiave di sol tavolo

Table lamp
in hand made
polished steel
15X9X38

Steel base
cm 15X9X1

Weight kg 1,5

1 Ministar led
2W - max 500mA
280 Lm emitted
3000°K - CRI 85
Dimmable power adapter
included

2700°K on request





n.96 SCHEGGE
in gold finishing

private installation

GENERAL information

Tutte le lampade Knikerboker vengono realizzate con materiali di qualità e sottoposte ad un attento controllo e collaudo finale.

Il controllo delle lampade durante le fasi della produzione ne garantisce la totale qualità.

I nostri prodotti sono contrassegnati e sottoposti all'applicazione delle normative CE ed appartengono alla Classe I, in IP 20.

Knikerboker garantisce i propri prodotti secondo le normative stabilite dalla comunità europea, dalla data di acquisto.

La garanzia dà diritto alla sostituzione, riparazione gratuita di tutte le parti soggette a vizi di fabbricazione, escludendo danni arrecati

da rotture di trasporto, riparazione da terzi, danni o manomissioni e da uso improprio.

La garanzia esclude le lampadine, i trasformatori e gli alimentatori.

E' escluso altresì il prolungamento della garanzia successivamente ad una riparazione del prodotto.

Nessuna responsabilità è assunta per danni accidentali a persone e/o cose in seguito all'uso improprio dei prodotti.

Dimmerazione:

Tutti gli articoli dimmerabili devono essere utilizzati con dimmer compatibili con le caratteristiche tecniche specificate sulle

etichette degli alimentatori/trasformatori.

Avvertenza:

Nella continua ricerca di miglioramento Knikerboker si riserva il diritto di apportare delle modifiche ai propri prodotti o parte degli stessi senza preavviso ed in qualsiasi momento.

Knikerboker

assolve l'obbligo dello smaltimento a norma di legge delle apparecchiature elettriche ed elettroniche, associandosi ai consorzi delle rispettive nazioni.

All Knikerboker's lamps are made with high quality material and they are submit to a careful inspection and final test.

The lamp's inspection during every step of production warrantee the quality.

The product is marked and submit to the European prescriptive and belongs to IP 20 in I Class.

Knikerboker warrantees these lamps, through the CE prescriptive from the date of purchase.

The guarantee gives the due of substitution, free repair of all the parts defective from the manufacture.

The guarantee does not apply to light, bulbs, transformers and power supplies shipping damage, damage resulting from alternations, unauthorized repairs of service, misuse or improper maintenance.

This guarantee shall not be extended, subsequent to repair beyond the warranty period.

No responsibility is assumed for any accidental damages to people and/or things arising out of the use or inability to use this product.

Dimming:

All dimmable items must be used with dimmers with the technical features specified on the labels of the power supplies/transformers.

Warning:

In its constant search for improvement, Knikerboker reserves the right to carry changes to the products or part of them without notice and in every moment.

Knikerboker

fulfills the obligation to dispose of the electric and electronical equipment according to law, joining different countries' corporations.

Alle Knikerboker Leuchten werden aus hochwertigen Materialien erstellt und einer aufmerksamen Endkontrolle unterzogen.

Die Kontrolle während der Produktion gewährleistet die Gesamtqualität. Unsere Produkte sind CE zertifiziert und gehören standardmäßig der Klasse I, IP 20 an.

Knikerboker haftet für die eigenen Produkte gemäß der EU- Regelungen ab dem Verkaufsdatum.

Produktionsmängel berechtigen im Rahmen der Garantie zum Austausch oder zur kostenlosen Reparatur der beschädigten Teile.

Transportschäden, Reparatur durch Dritte, unbefugte Eingriffe oder nicht ordnungsgemäße Verwendung sind von der Garantie ausgenommen.

Von der Garantie sind Leuchtmittel, Transformatoren und Betriebsgeräte ausgeschlossen. Ebenso ist die Verlängerung der Garantie nach einer erfolgten Reparatur ausgeschlossen.

Für Schäden an Personen und/oder Sachen durch unsachgemäße Verwendung der Produkte wird nicht gehaftet.

Dimmbarkeit:

Für alle dimmbaren Produkte müssen Dimmer genutzt werden, die kompatibel mit den technischen Eigenschaften der Trafos oder Betriebsgeräten sind.

Entsprechende Hinweise befinden sich auf den Etiketten.

Hinweise:

Knikerboker behält sich vor, eigene Produkte ohne Vorankündigung jederzeit zu modifizieren oder zu verbessern.

Knikerboker

erfüllt die Pflicht der Entsorgung von Elektronik und Elektrogeräten laut der entsprechenden Elektrogenetzen.

Our finishings

PAINTED FINISHINGS

embossed white
embossed black
metallic anthracite
coffee
purple red
rust
embossed brown
sahara
champagne
antique pink
satin copper

B 
N 
MA 
CA 
PR 
RU 
BR 
S 
CH 
R 
RS 

gold leaf/white
silver leaf/white
copper leaf/white
bronze leaf/white

TO/B 
TA/B 
TR/B 
TB/B 

gold leaf/black
silver leaf/black
copper leaf/black
bronze leaf/black

TO/N 
TA/N 
TR/N 
TB/N 

gold leaf/metallic anthracite
silver leaf/metallic anthracite
copper leaf/metallic anthracite
bronze leaf/metallic anthracite

TO/MA 
TA/MA 
TR/MA 
TB/MA 

gold leaf/coffee
silver leaf/coffee
copper leaf/coffee
bronze leaf/coffee

TO/CA 
TA/CA 
TR/CA 
TB/CA 

gold leaf/purple red
silver leaf/purple red
copper leaf/purple red
bronze leaf/purple red

TO/PR 
TA/PR 
TR/PR 
TB/PR 

LEAF FINISHINGS

gold leaf
silver leaf
copper leaf
bronze leaf

TO 
TA 
TR 
TB 

gold leaf/embossed brown
silver leaf/embossed brown
copper leaf/embossed brown
bronze leaf/embossed brown

TO/BR 
TA/BR 
TR/BR 
TB/BR 

gold leaf/sahara
silver leaf/sahara
copper leaf/sahara
bronze leaf/sahara

TO/S 
TA/S 
TR/S 
TB/S 

gold leaf/champagne
silver leaf/champagne
copper leaf/champagne
bronze leaf/champagne

TO/CH 
TA/CH 
TR/CH 
TB/CH 

gold leaf/antique pink
silver leaf/antique pink
copper leaf/antique pink
bronze leaf/antique pink

TO/R 
TA/R 
TR/R 
TB/R 

gold leaf/satin copper
silver leaf/satin copper
copper leaf/satin copper
bronze leaf/satin copper

TO/RS 
TA/RS 
TR/RS 
TB/RS 

In caso di doppia finitura, il primo colore coincide con l'esterno, il secondo con l'interno.

Per esempio: foglia argento (esterno) bianco (interno)

Finiture speciali "a richiesta"

La finitura ruggine non è disponibile per tutte le collezioni.

In case of double finishing, the first color coincides with outside, the second one with inside.

For example: silver leaf (outside) white (inside)

Special finishings "on request"

Rust finishing is not available for all the collections.

Bei einer doppelten Oberflächenbehandlung ist die erste Farbe für die Außenseite und die zweite für die Innenseite der Leuchte bestimmt.

Zum Beispiel: Blattsilber (außen) weiß (innen)

Sonderausführungen auf Anfrage

Die Rostausführung ist nicht für alle Kollektionen verfügbar

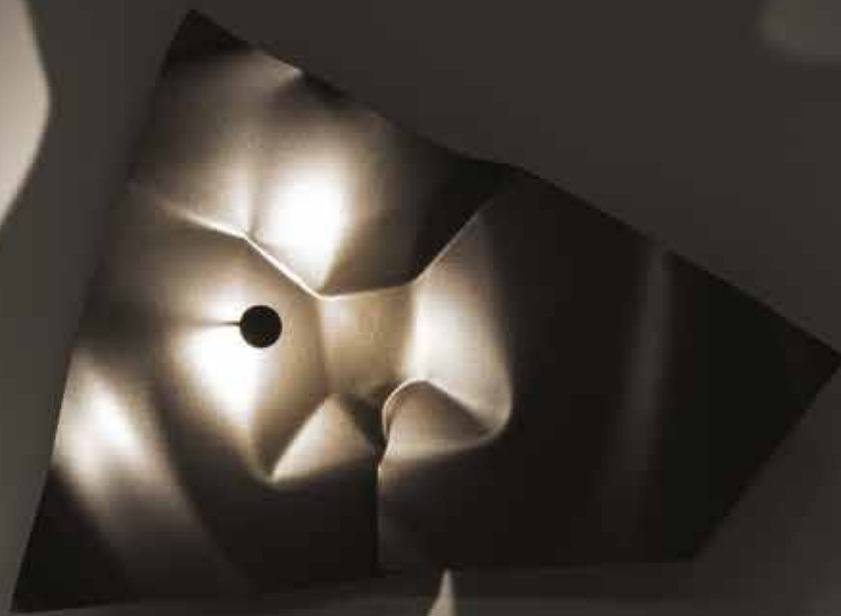

knikerboker
the art of hand made



knikerboker s.r.l. - via Delle Rose,7 - 24040 Lallio (Bg) Italy
tel. +39 (0)35 200536 - fax +39 (0)35 4327902 - p.iva/cf 03091640163
info@knikerboker.it - www.knikerboker.it - skype: infoknikerboker

L'ULTIMA LUNA

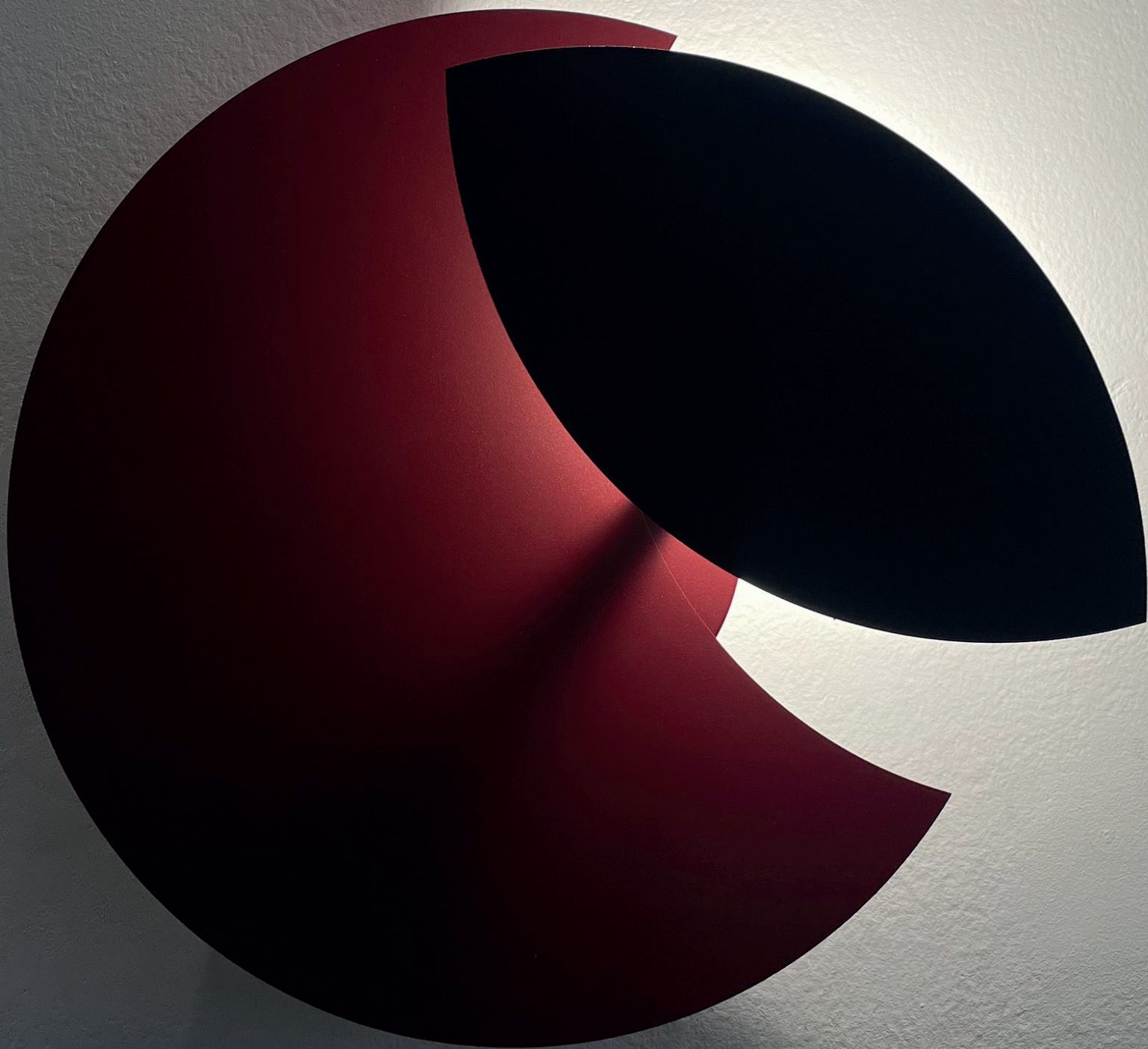
2026 NEWS



knikerboker
the art of hand made



L'ULTIMA LUNA

è una lampada da parete e da plafone ispirata alle fasi lunari, nasce dall'incontro di superfici curve che si sovrappongono e si inseguono grazie ad uno snodo rotabile, creando un equilibrio delicato tra pieni e vuoti, luce e ombra. La luce si diffonde morbida disegnando aloni cangianti che mutano con la rotazione. Ogni composizione evoca un istante diverso, come l'ultima luna prima del cambiamento. L'Ultima Luna può vivere come elemento singolo o come installazione modulare, dando ritmo e profondità agli spazi residenziali e contract. Una presenza discreta ma memorabile, dove il design diventa atmosfera.

L'ULTIMA LUNA

is a wall and ceiling lamp inspired by the phases of the moon. It is born from the encounter of curved surfaces that overlap and chase one another through a rotating joint, creating a delicate balance between solids and voids, light and shadow. The light diffuses softly, tracing shifting halos that evolve with each rotation. Every composition evokes a different moment — like the last moon before change. L'Ultima Luna can exist as a single element or as a modular installation, bringing rhythm and depth to residential and contract spaces. A discreet yet memorable presence, where design becomes atmosphere.

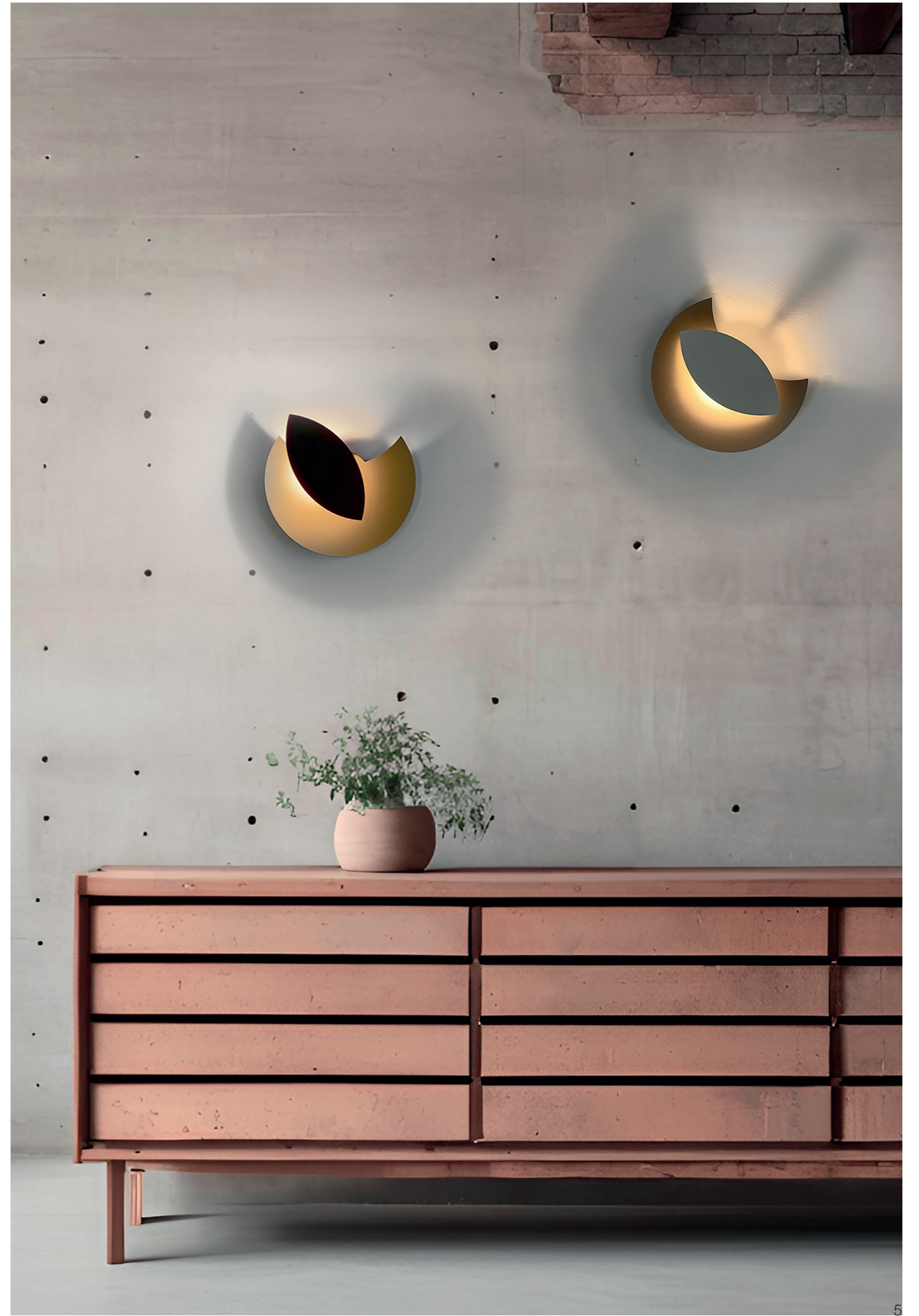
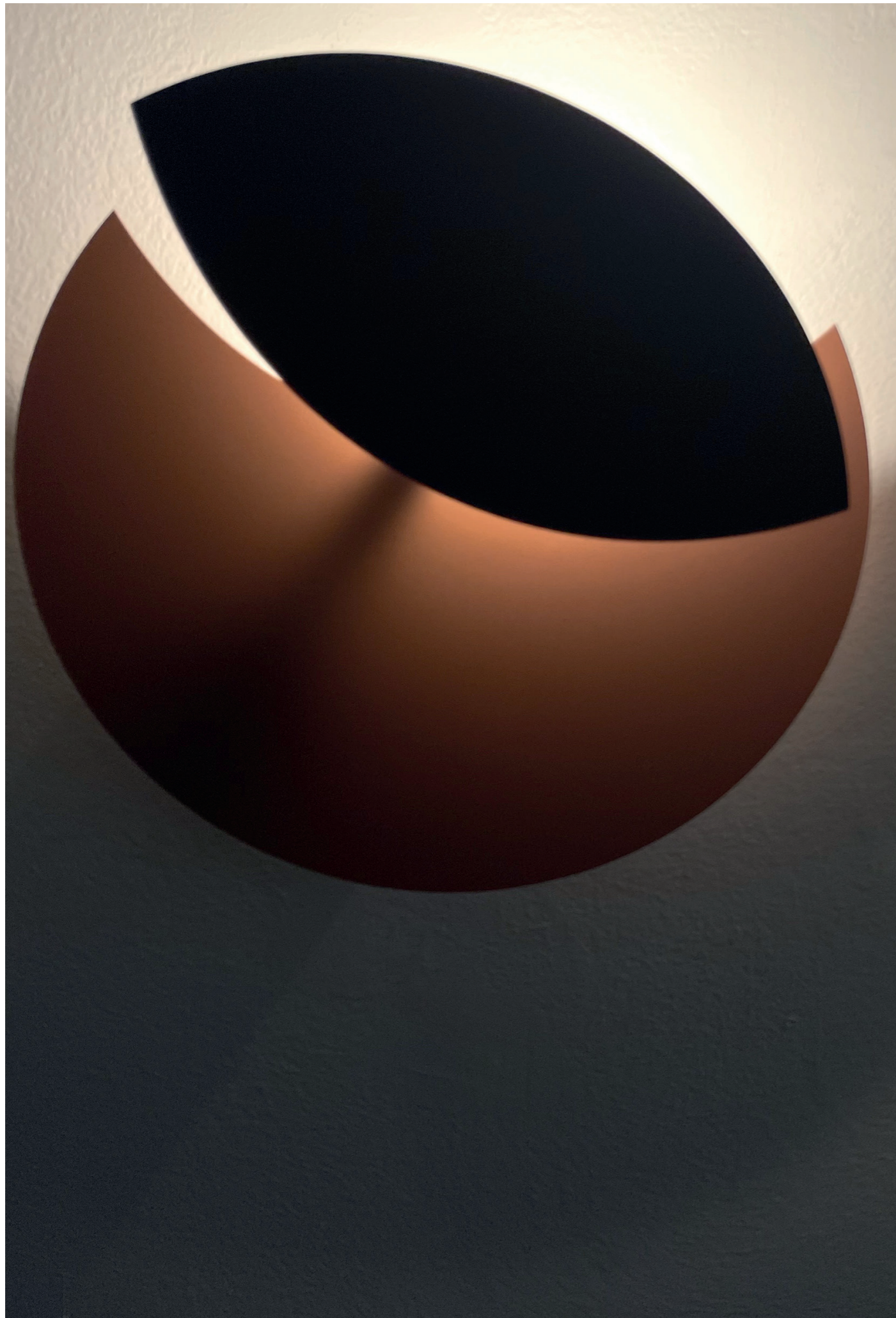

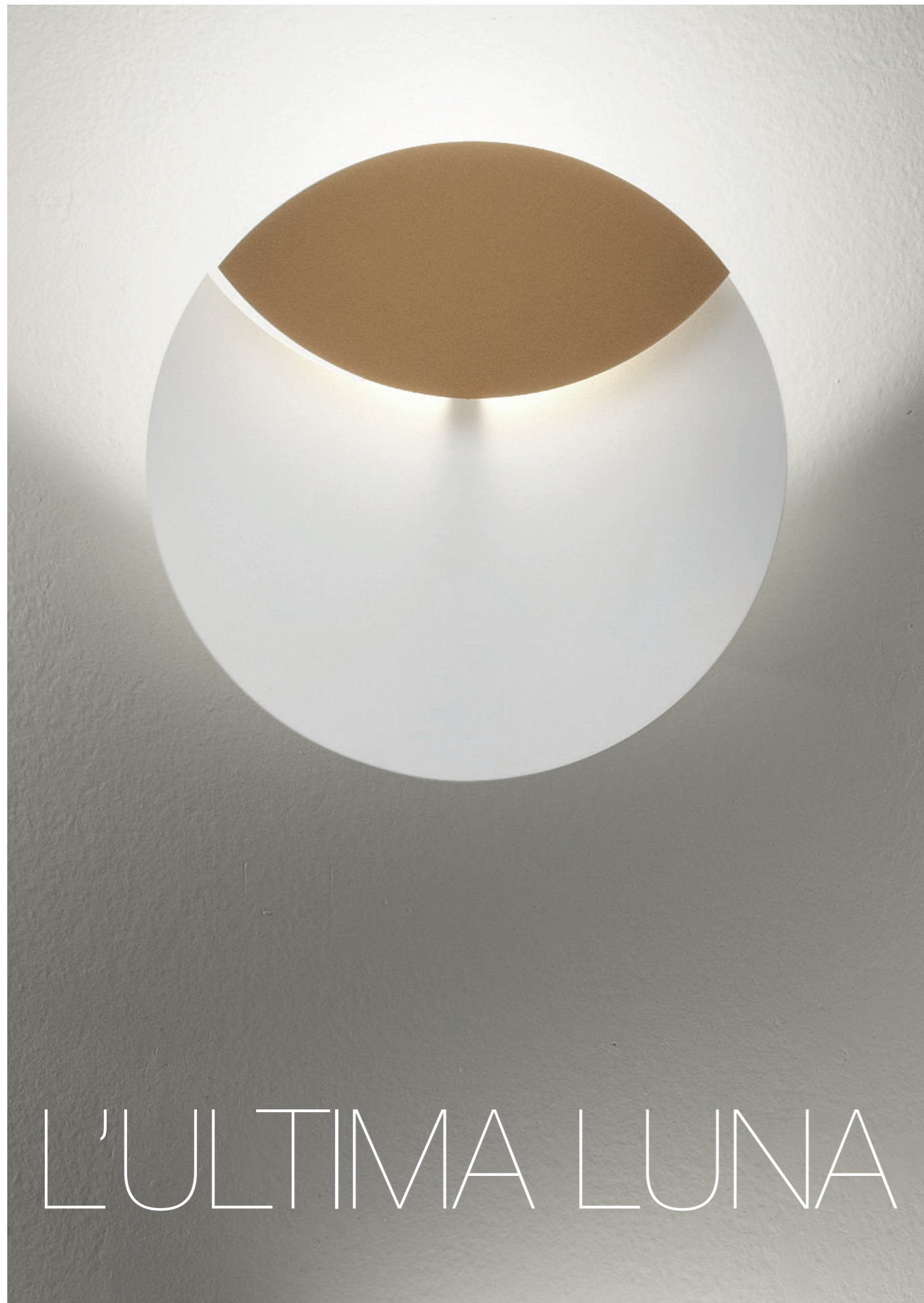

L'ULTIMA LUNA



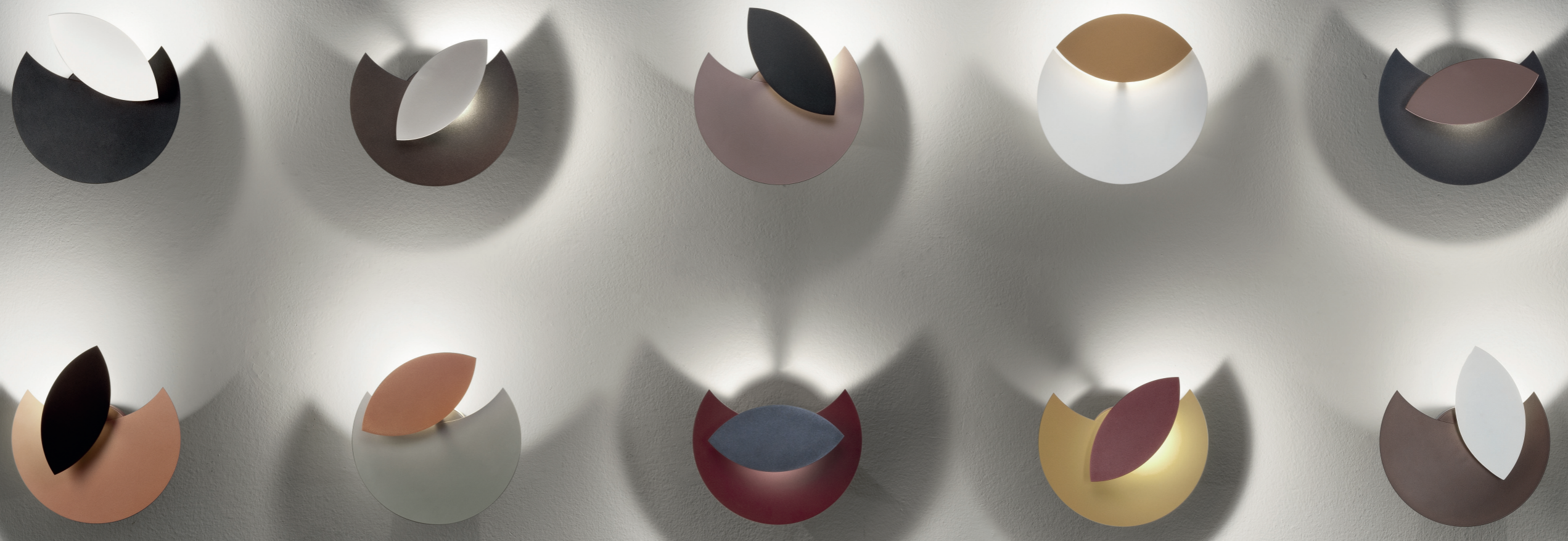

THE PURCHASING METHOD MUST RESPECT THE FOLLOWING FEATURES:

- The first letter coincides with the base finishing
- The second one coincides with the ellipse finishing

For example: Base coffee
 Ellipse copper leaf CA/TR

embossed white B
 embossed black N
 metallic anthracite MA
 coffee CA
 purple red PR
 embossed brown BR

sahara S
 champagne CH
 antique pink R
 satin gold OS
 satin copper RS

silver leaf TA
 gold leaf TO
 copper leaf TR
 bronze leaf TB

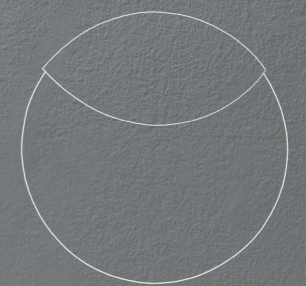
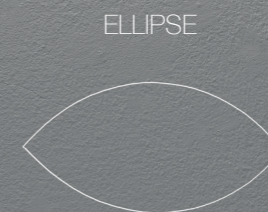
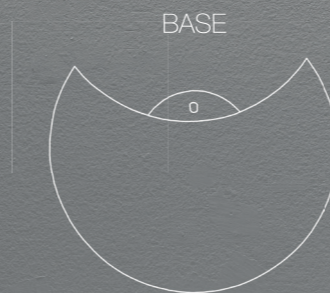

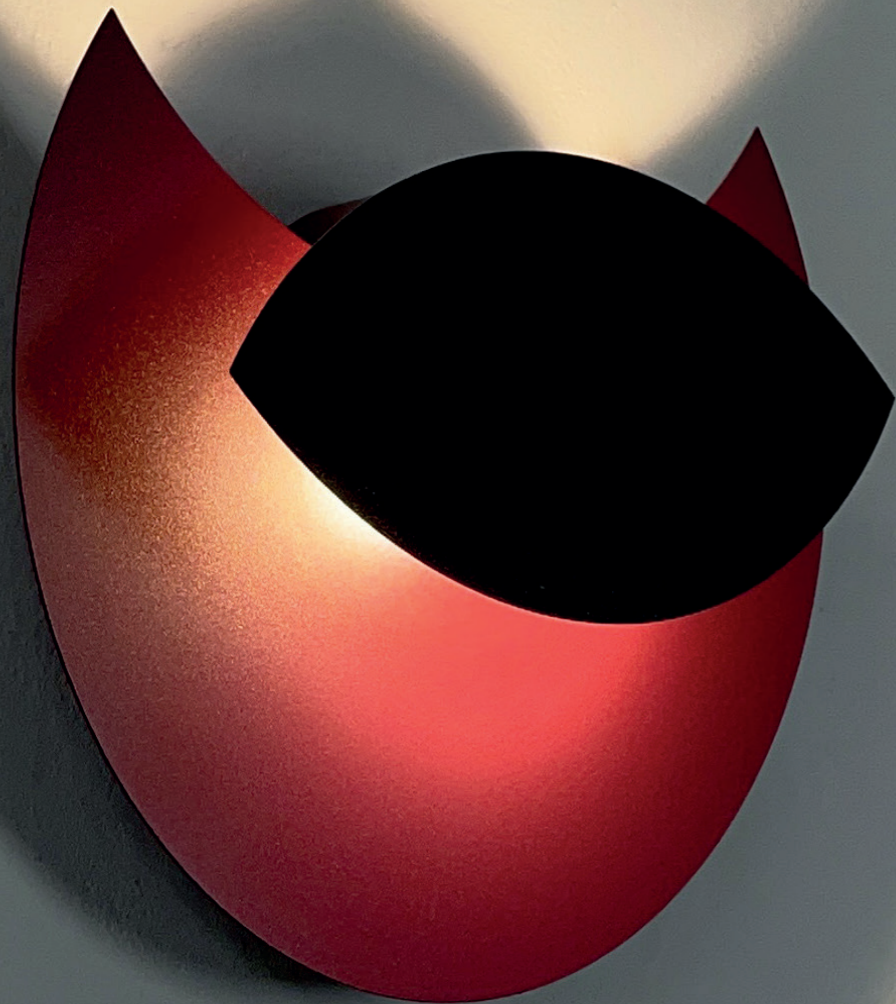

L'ULTIMA LUNA 30

Wall/ceiling lamp
in polished steel Ø cm 30X9,5

Spread cm 9,5

Weight kg 0,9

1 led COB
16W - max 500mA
2900 Lm emitted
3000°K - CRI>85
Phase cut dimmable
power supply included

2700°K and other dimming
ways on request

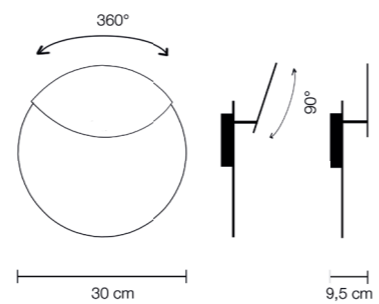

L'ULTIMA LUNA 40

Wall/ceiling lamp
in polished steel Ø cm 40X10

Spread cm 10

Weight kg 1,4

1 led COB
16W - max 500mA
2900 Lm emitted
3000°K - CRI>85
Phase cut dimmable
power supply included

2700°K and other dimming
ways on request

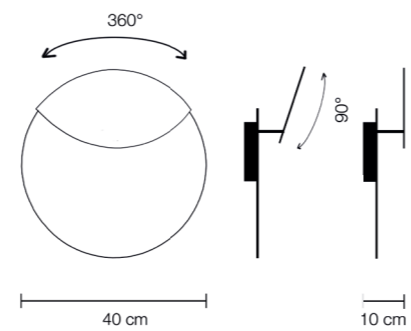

L'ULTIMA LUNA



IN FOGLIA



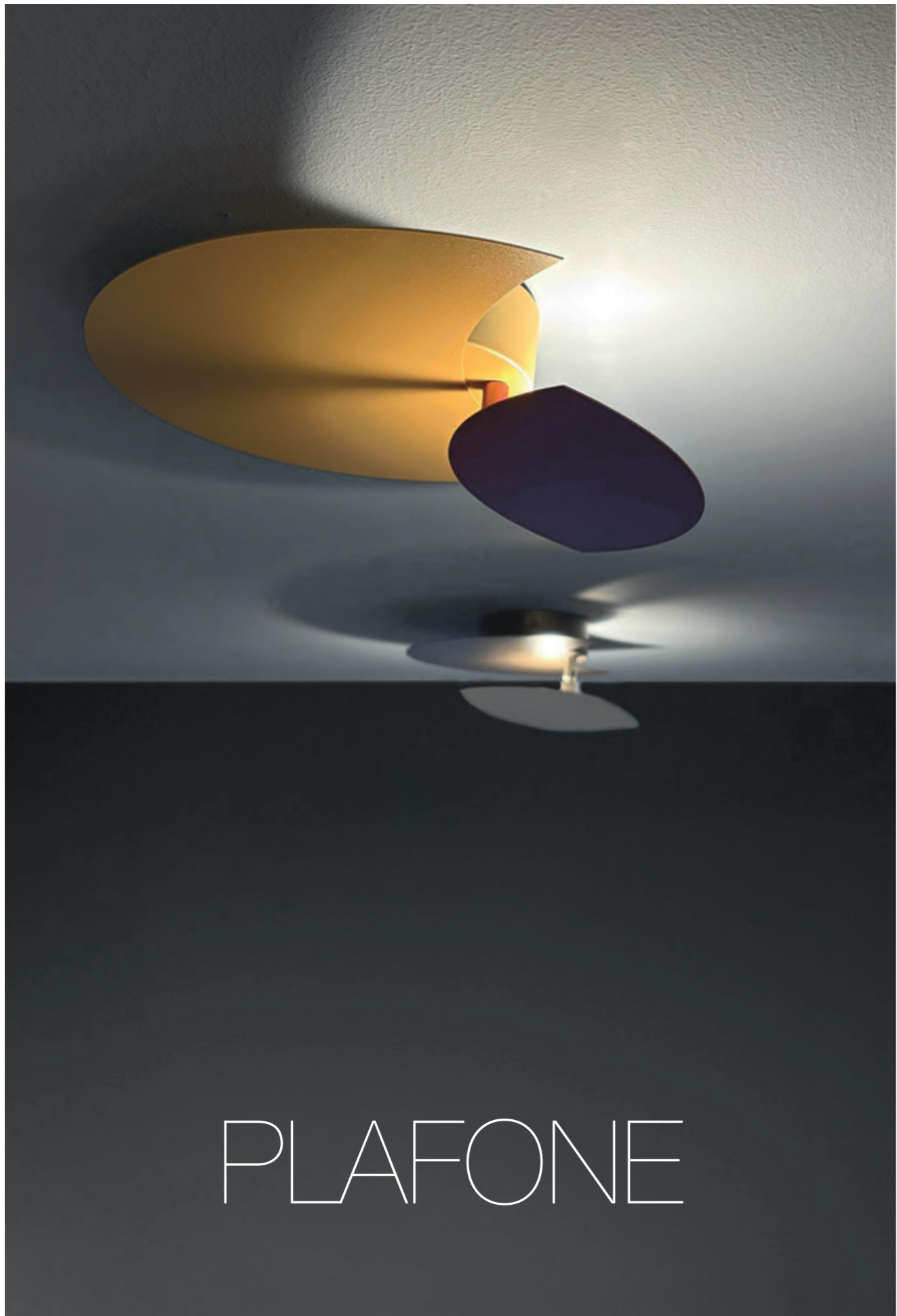

PLAFONE



... con grandi ali prese la luna tra le mani,
tra le mani
e volò via
e volò via ...
era l'uomo di domani

...grazie Lucio...



knikerboker
the art of hand made

Knikerboker s.r.l. - via Delle Rose,7 - 24040 Lallio (Bg) Italy
tel. +39 (0)35 200536 - fax +39 (0)35 4327902 - p.iva/cf 03091640163
info@knikerboker.it - www.knikerboker.it - instagram: @knikerboker